

How to assemble a 6 Foot Incandescent Christmas Wreath

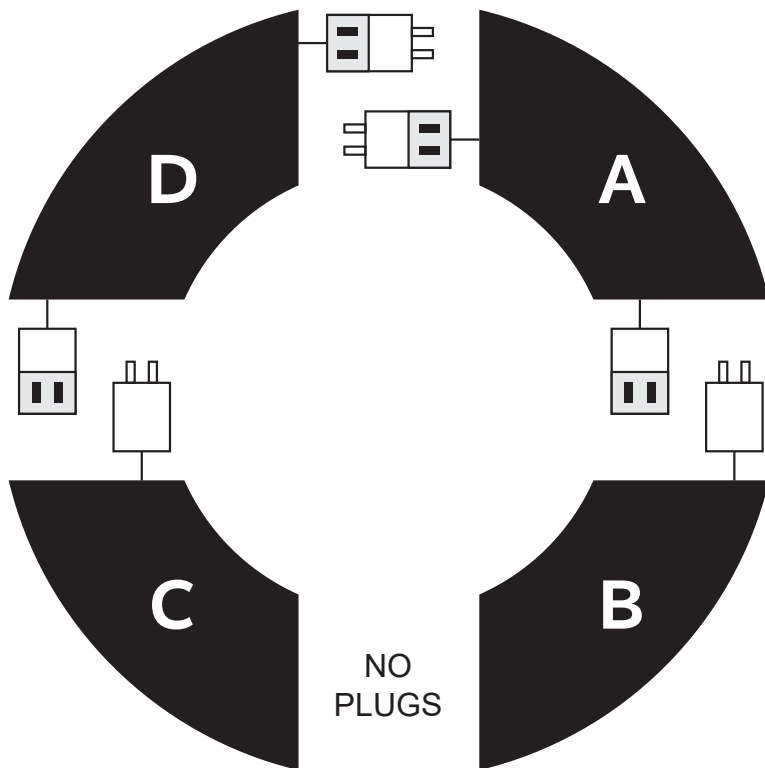

Specifications
6 Foot Christmas Wreath

1320 Tips
4 Piece Construction
Outer Wire Frame Dimensions: 56"
Inner Wire Frame Dimensions: 45"
Outer Tip (branch) Extension: 8" per side
Outer Frame + Tip Extension: 72"

56" Outer Ring

72" Tip to Tip
Widest outer point

Step 1: Place wreath sections pine side down (**frame side up**) as displayed above.

Step 2: Plug A and B together. Plug C and D together.

Step 3: Plug A and D together (piggy-backed) and plug this into your extension cord. The whole wreath should now be lit.

NOTE: B and C will not plug together.

Step 4: Securely connect the sections using the nuts and bolts provided.

Step 5: Fluff and shape the pines to bring out the fullness and beauty of your wreath.

Optional Bow: If using a lighted bow, plug into the back of A and D. You will now have 3 plugs (piggy-backed) together.

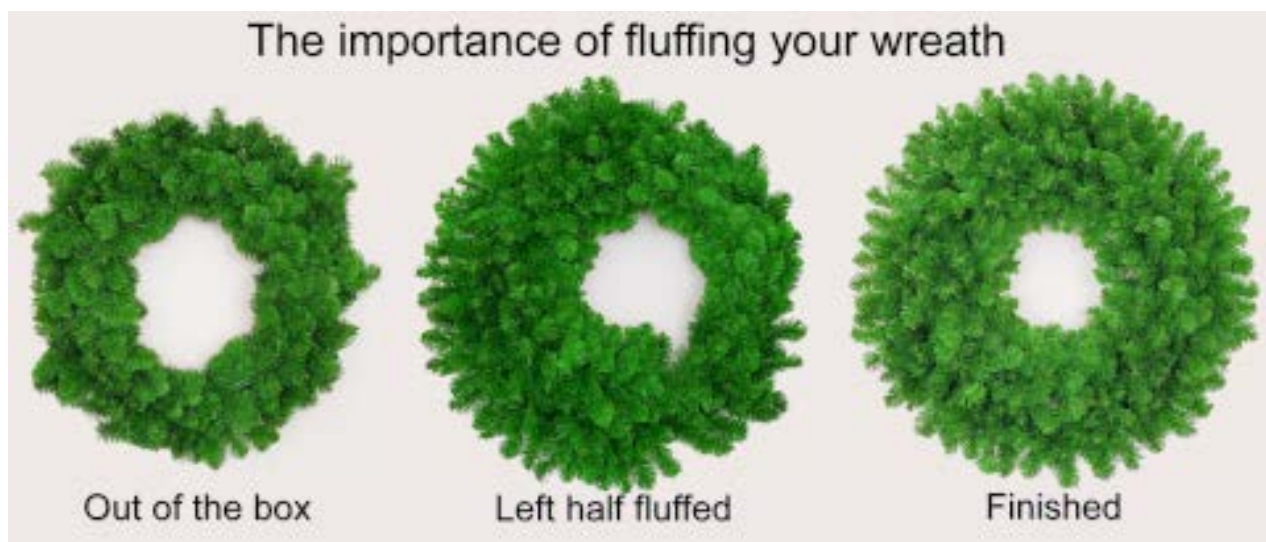

***If you have any questions, please call us at: 732-449-9427.
We're glad to help!***

Thank you for your order!

Artificial Christmas Wreaths (ACWreaths®)

732-449-9427

